

Type	SPX 1275
Max. hijscapaciteit	7.5t x 2.00 meter
Max. hijshoogte	26.50 meter x 560 kg
Max. vlucht	20.00 meter x 100 kg
Zwenkbereik	360°
Bereik onder grond niveau	
Twee-schijfs haakblok	20.00 meter
Balhaak	70.00 meter
Banden	Rupsbanden
Bediening kraan	Radiografisch
Veiligheid	Voorzien van LMB
Rijsnelheid	3.1 km/u
Klimvermogen	20°
Eigen gewicht	8.700 kg
Eigen gewicht (+ jib)	9.380 kg
Bodemdruk bij transport	0.72 kg / cm ²
Rupsafmetingen	1984 x 400 mm
Aandrijving	Dieselmotor / 400V/32A
Max. stempeldruk per poot	6.800 kg
Afmetingen	
Lengte	5727 / 7465 mm
Breedte	1450 / 2050 mm
Hoogte	2040 mm

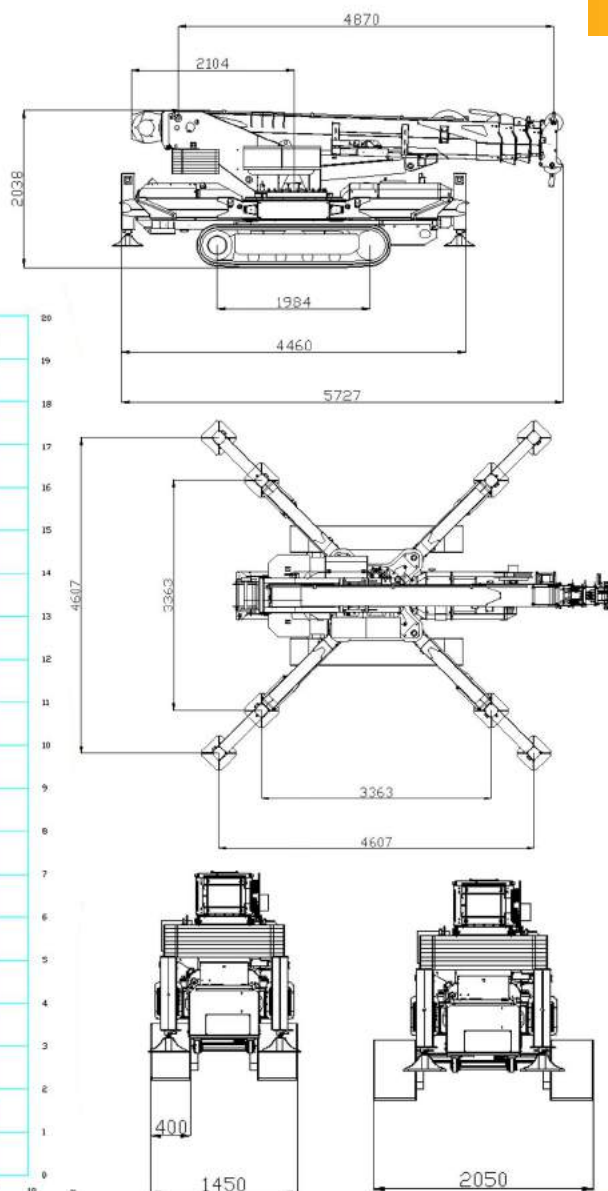

AFMETINGEN SPX 1275



WERKDIAGRAM SPX 1275 HOOFDMAST

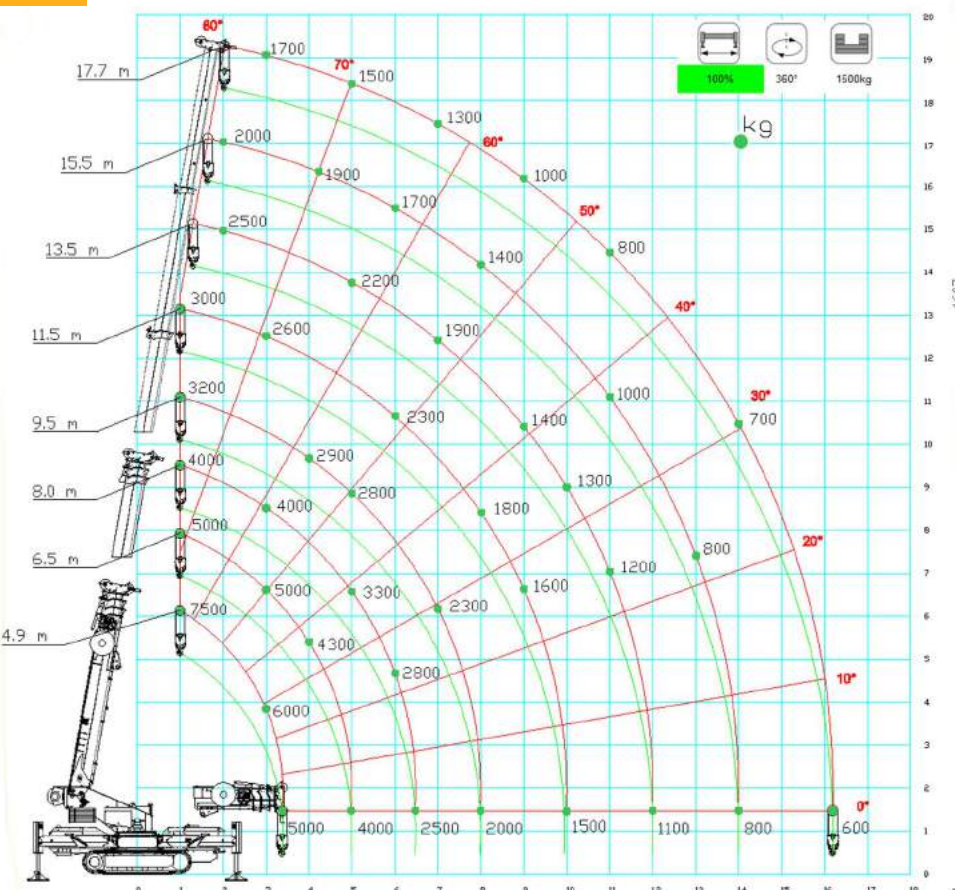

WERKDIAGRAM SPX 1275 MET JIB1500.3HL

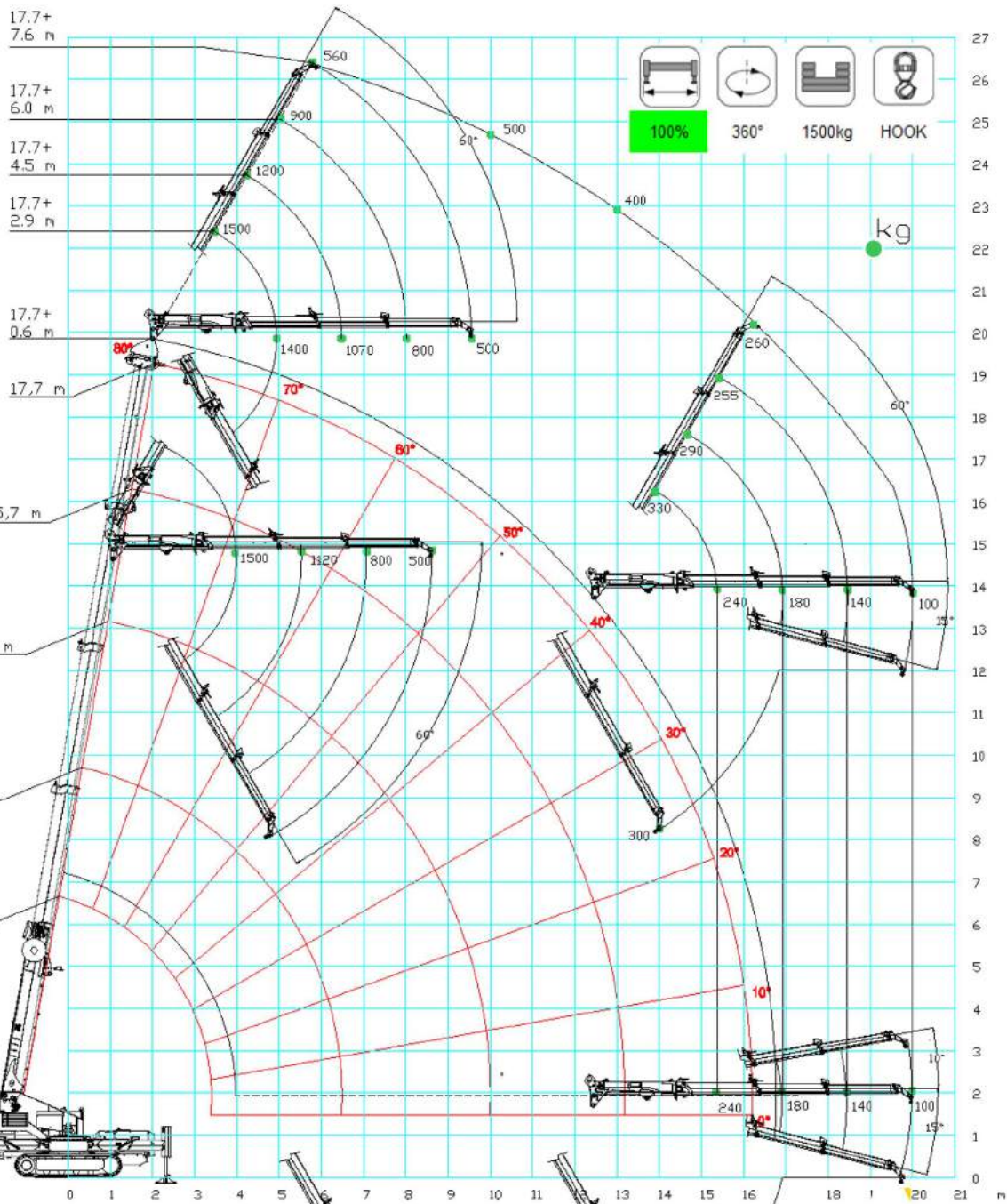

AFMETINGEN JIB1500.3HL

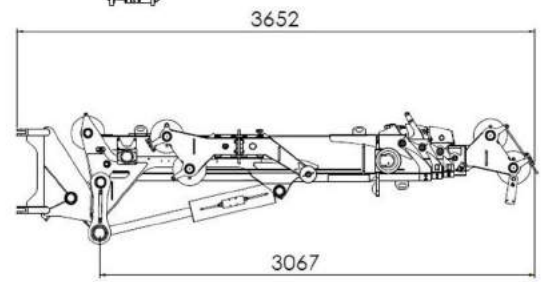
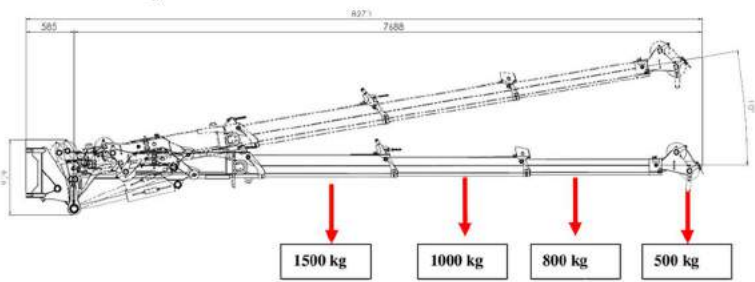
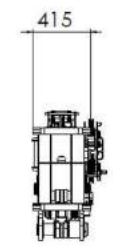
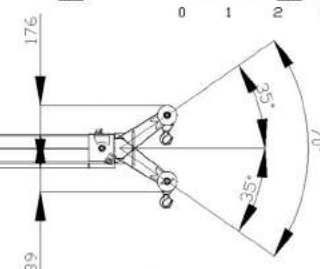

WERKDIAGRAM SPX 1275 MET JIB3500G

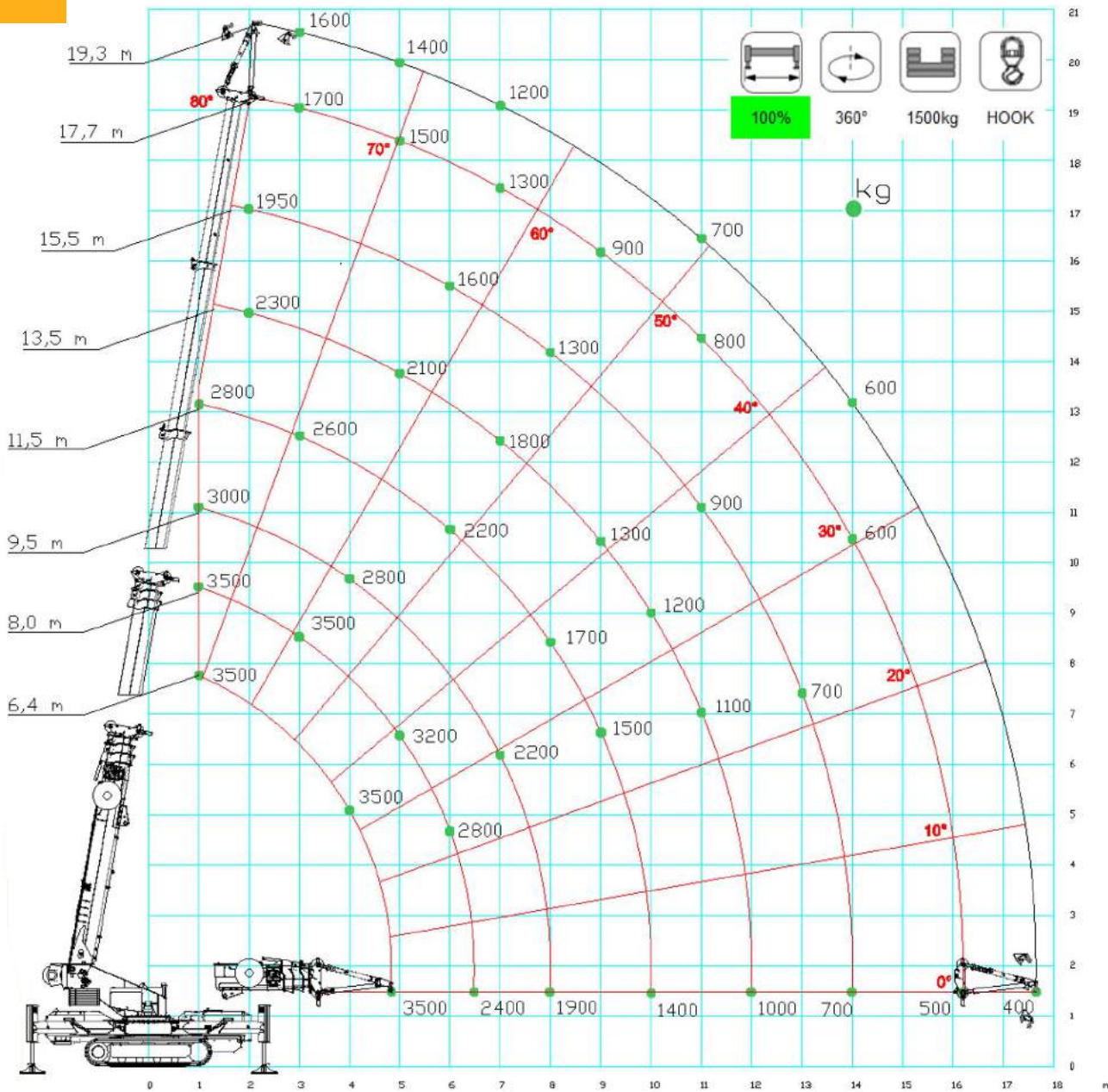

HIJDIAGRAM SPX 1275 HOOFDMAST PICK & CARRY

